

5

4

3

2

1

D

D

C

C

B

B

A

A

DB9 电源插头

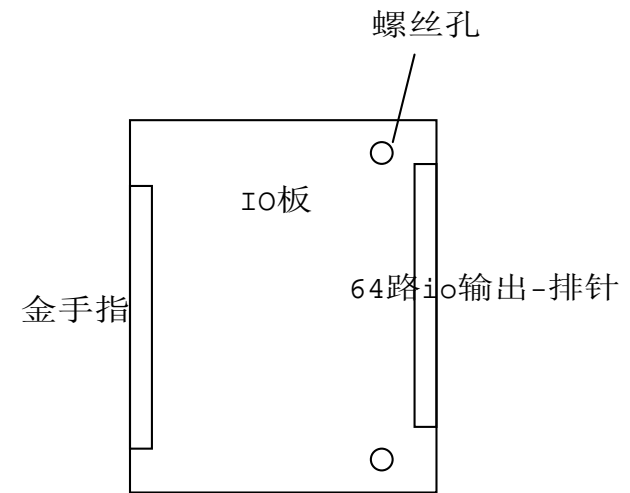
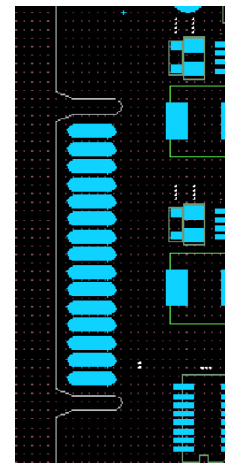
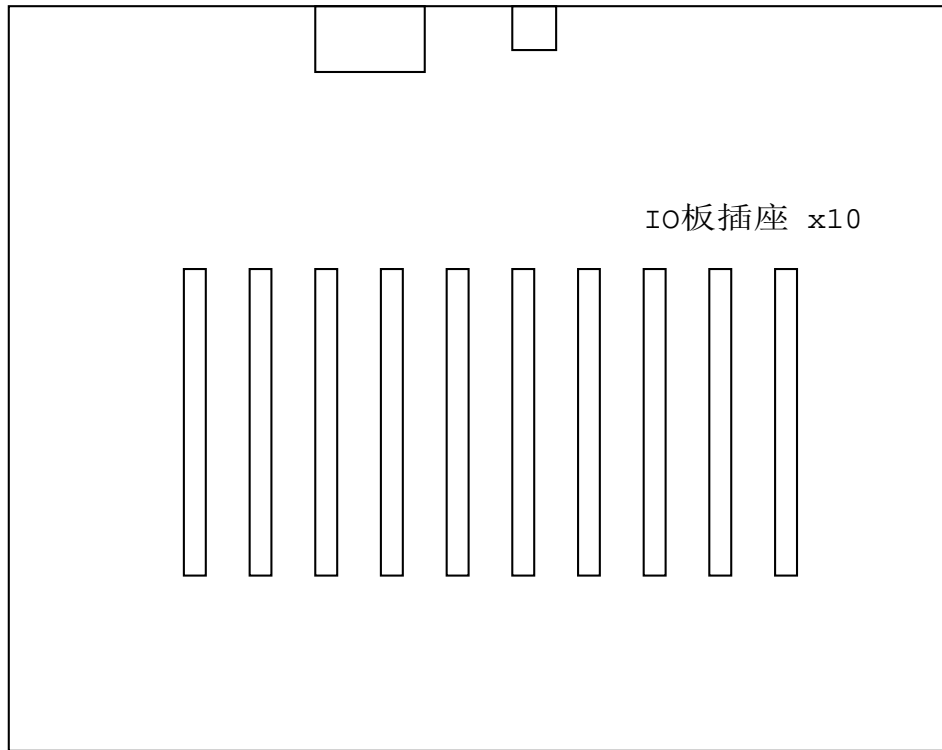

Title		
底板		
Size	Document Number	Rev
A	<Doc>	<RevCode>
Date:	Tuesday, August 02, 2016	Sheet 1 of 3

5

4

3

2

1

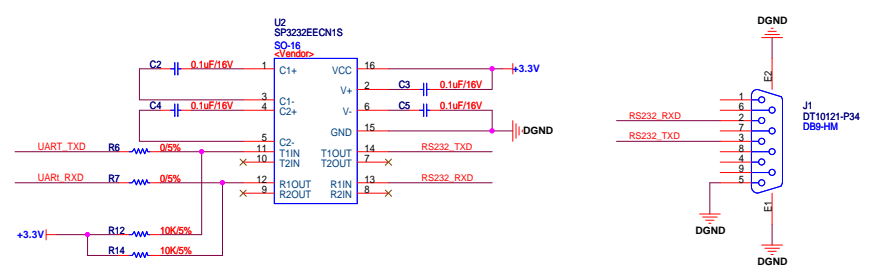
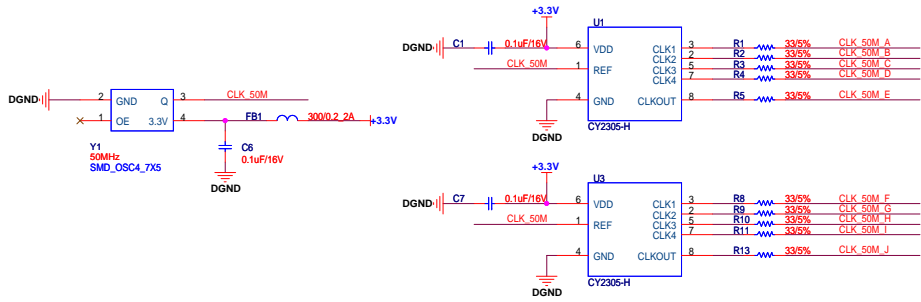

A

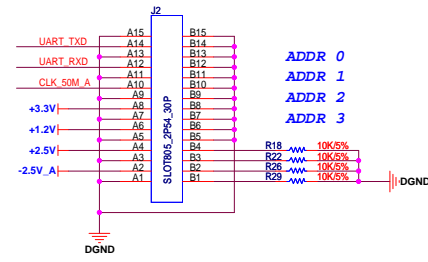

B

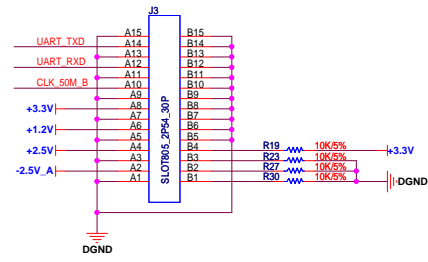

C

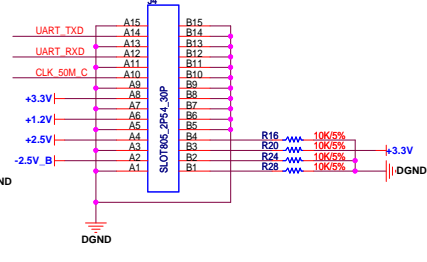

D

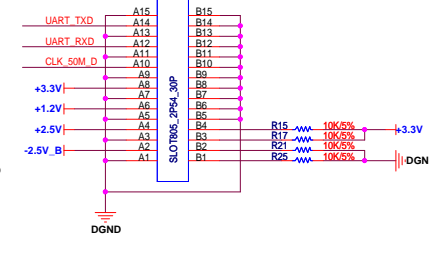

E

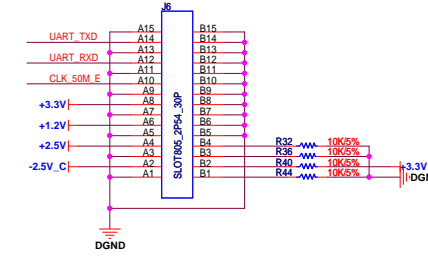

F

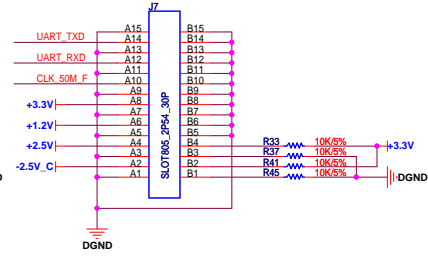

G

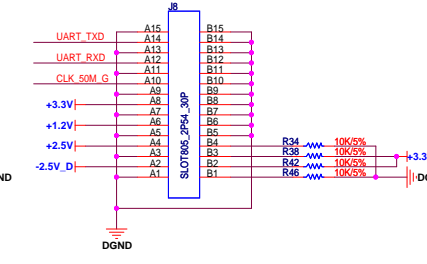

H

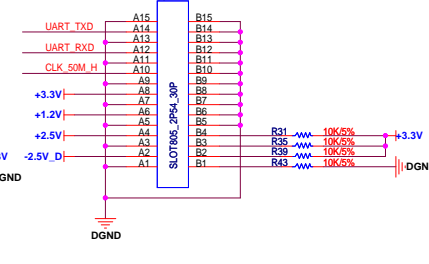

I

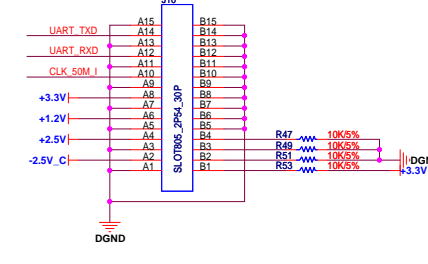

J

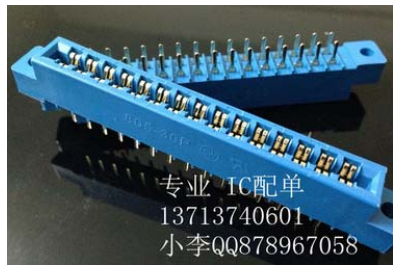
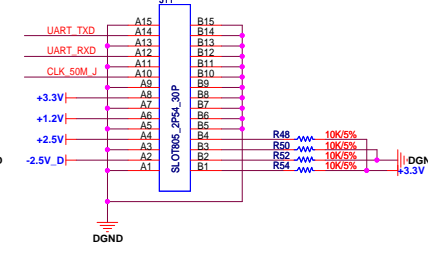

File	底板		Rev	
Size	Document Number	<Doc>		
Date:	Tuesday, August 02, 2016	Sheet	2	of 3

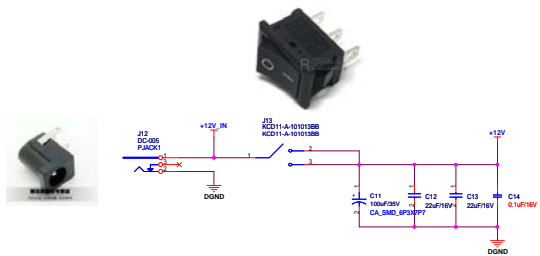

IO 电源

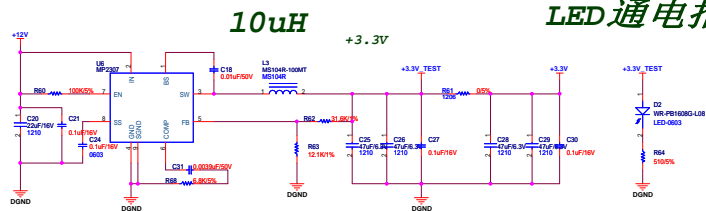

FPGA CORE

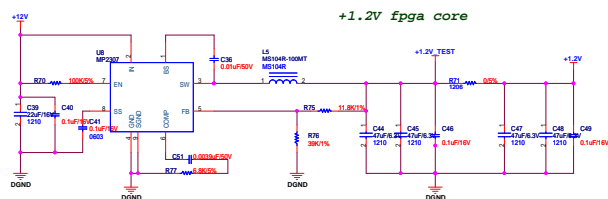

螺丝孔



调试时，请断开电源的0欧电阻，
确认所有电源电压正常、后级无短路后，
方可连接调试后级电路

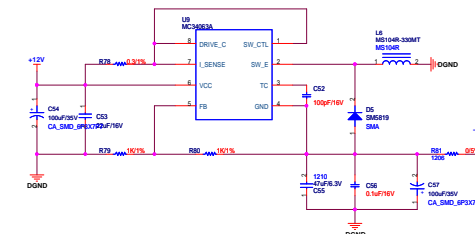
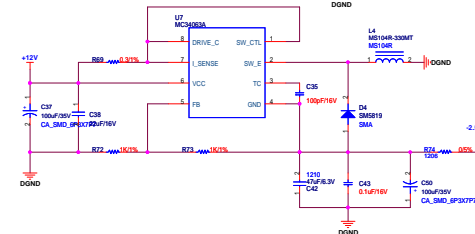
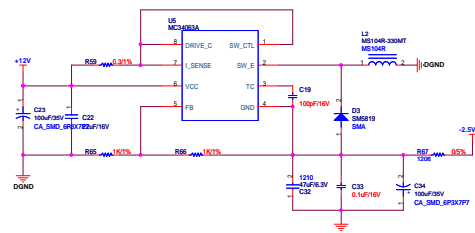
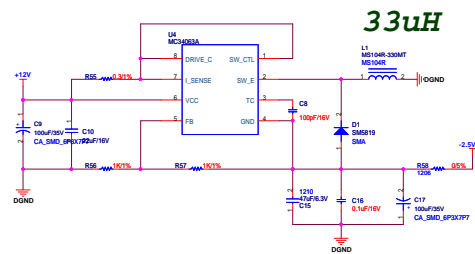

运放负电源

400mA max
for amp(2.3mA/amplifier)

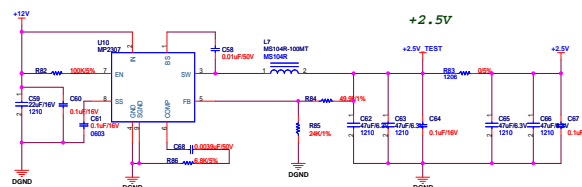

运放电源&FPGA AUX

File	板框	Rev	
Rev	Document Number	Rev	
D	0000	1	
DATE	1999.09.01	Page	1 of 1